

# Thermoplastic SUCTFL 200 Series

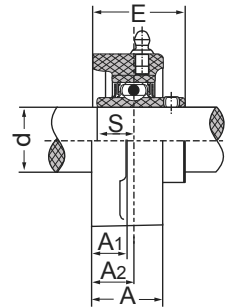
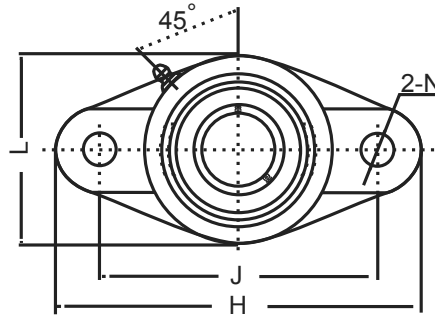

Unit No.	Shaft Diameter (inch / mm)	Dimensions (inch / mm)									Bolt Size	Bearing No.	Housing No.	Mass	
		d	H	J	L	A1	A	N	E	A2				S	kg
SUCTFL 201 201-8 202 202-10 203 204-12 204	12 mm 1/2 15 mm 5/8 17 mm 3/4 20 mm	4-7/16 113	3-35/64 90	2-35/64 65	7/16 11.4	1-3/64 26.5	7/16 11	1-21/64 33.7	39/64 15.5	1/2 12.7	3/8 M10	SUC 201 201-8 202 202-10 203 204-12 204	TFL 204	.29	.71
SUCTFL 205-14 205-15 205 205-16	7/8 15/16 25 mm 1	5-1/2 130	3-57/64 99	2-47/64 69.5	17/32 13.5	1-9/64 29.1	7/16 11	1-29/64 36.7	43/64 17	9/16 14.3	3/8 M10	SUC 205-14 205-15 205 205-16	TFL 205	.34	.80
SUCTFL 206-18 206 206-19 206-20	1-1/8 30 mm 1-3/16 1-1/4	5-13/16 148	4-39/64 117	3-9/64 80	33/64 13.1	1-13/64 30.5	7/16 11	1-5/8 41.4	3/4 19	5/8 15.9	3/8 M10	SUC 206-18 206 206-19 206-20	TFL 206	.54	1.12
SUCTFL 207-20 207-21 207-22 207 207-23	1-1/4 1-5/16 1-3/8 35 mm 1-7/16	6-7/16 164	5-1/8 130	3-35/64 90	5/8 16.1	1-19/64 32.8	33/64 13	1-45/64 43.4	45/64 18	11/16 17.5	1/2 M12	SUC 207-20 207-21 207-22 207 207-23	TFL 207	.78	1.65
SUCTFL 208-24 208-25 208	1-1/2 1-9/16 40 mm	6-7/8 174.5	5-43/64 144	3-15/16 100	25/32 20	1-15/32 37.5	9/16 14	2-1/32 51.7	27/32 21.5	3/4 19	1/2 M12	SUC 208-24 208-25 208	TFL 208	.97	2.15
SUCTFL 209-26 209-27 209-28 209	1-5/8 1-11/16 1-3/4 45 mm	7-7/16 188.5	5-27/32 148.5	4-1/4 108	53/64 21	1-39/64 41	43/64 17	2-9/64 54.2	15/16 24	3/4 19	5/8 M16	SUC 209-26 209-27 209-28 209	TFL 209	1.09	2.45
SUCTFL 210-30 210-31 210 210-32	1-7/8 1-15/16 50 mm 2	7-3/4 197	6-3/16 157	4-33/64 115	53/64 21	1-11/16 43	43/64 17	2-17/64 57.6	63/64 25	3/4 19	5/8 M16	SUC 210-30 210-31 210 210-32	TFL 210	1.20	2.79