

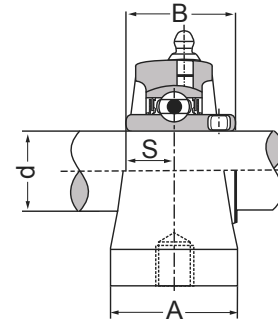

Tapped-Based Pillow Blocks

Stainless Steel - SSUCPA_A Series

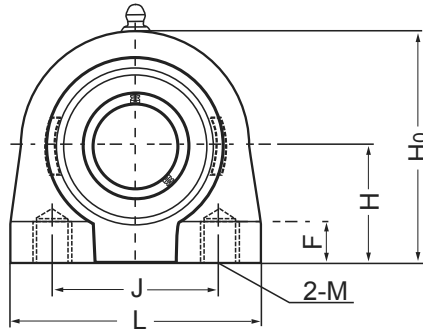
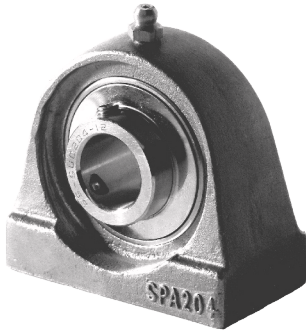

Also available with eccentric locking collar bearing

Unit No.	Shaft Dia. (inch / mm)	Dimensions (inch / mm)									Bearing No.	Housing No.	Mass		
		d	H	L	J	A	H0	B	S	F			M	kg	lbs
SSUCPA 201A 201-8A 202A 202-10A 203A 204-12A 204A	12 mm 1/2 15 mm 5/8 17 mm 3/4 20 mm	1-5/16 33.3	2-3/4 69.9	2 50.8	1-1/2 38.0	2-9/16 65.0	1-7/32 31.0	23/32 18.5	1/2 12.5		3/8-16 NC	SUC 201 201-8 202 202-10 203 204-12 204	SPA 204A	0.8	1.8
SSUCPA 205-14A 205-15A 205A 205-16A	7/8 15/16 25 mm 1	1-7/16 36.5	3 76.2	2 50.8	1-1/2 38.0	2-13/16 71.5	1-3/8 35.0	13/16 20.5	1/2 12.5		3/8-16 NC	SUC 205-14 205-15 205 205-16	SPA 205A	0.9	2.0
SSUCPA 206-18A 206A 206-19A 206-20A	1-1/8 30 mm 1-3/16 1-1/4	1-11/16 42.9	4 101.5	3 76.2	1-1/2 38.0	3-13/32 86.5	1-1/2 38.0	7/8 22.0	5/8 16.0		7/16-14 NC	SUC 206-18 206 206-19 206-20	SPA 206A	1.4	2.5
SSUCPA 207-20A 207-21A 207-22A 207A 207-23A	1-1/4 1-5/16 1-3/8 35 mm 1-7/16	1-7/8 47.6	4-1/4 108.0	3-1/4 82.6	1-7/8 47.5	3-3/4 95.5	1-11/16 43.0	1 25.5	3/4 19.0		1/2-13 NC	SUC 207-20 207-21 207-22 207 207-23	SPA 207A	1.6	3.4
SSUCPA 208-24A 208-25A 208A	1-1/2 1-9/16 40 mm	1-15/16 49.2	4-5/8 117.5	3-1/2 88.9	1-7/8 47.5	3-15/16 100.0	1-15/16 49.0	1-3/16 30.0	3/4 19.0		1/2-13 NC	SUC 208-24 208-25 208	SPA 208A	2	4.4
SSUCPA 209-26A 209-27A 209-28A 209A	1-5/8 1-11/16 1-3/4 45 mm	2-1/8 54.0	5 127	3-3/4 95.3	2 51.0	4-1/4 108.0	1-15/16 49.0	1-3/16 30.0	3/4 19.0		1/2-13 NC	SUC 209-26 209-27 209-28 209	SPA 209A	2.6	5.7
SSUCPA 210-30A 210-31A 210A 210-32A	1-7/8 1-15/16 50 mm 2	2-1/4 57.2	5-1/2 132.0	4 101.6	2 51.0	5-5/8 117.5	2-1/32 51.5	1-9/32 32.5	7/8 22.0		5/8-11 NC	SUC 210-30 210-31 210 210-32	SPA 210A	2.3	5.1

Other sizes could be available upon request. Minimum quantity may apply.
Please refer to page 52 for setscrew maximum torque informations.